

**performing  
databases**

# Gateway to Hell - Networking Basics

Martin Klier   
Performing Databases GmbH  
Mitterteich / Germany

# Speaker

- Martin Klier
- Solution Architect and Database Expert
- My focus:
  - Performance + Tuning
  - Highly available systems
  - Cluster and Replication
- Linux since 1997
- Oracle Database since 2003
- Ham Radio: DO6USN



# Performing Databases

- Three Experts for Database technology
  - Concepts and Project Competence
  - Architecture- and System planning
  - Licensing
  - Implementation and Troubleshooting
- Get in touch
  - Performing Databases GmbH  
Wiesauer Strasse 27  
95666 Mitterteich // Germany
  - <http://www.performing-databases.com>
  - Social: @PerformingDB



# Performing Databases Services



Monitoring / Alerting



Expert Level  
Knowhow

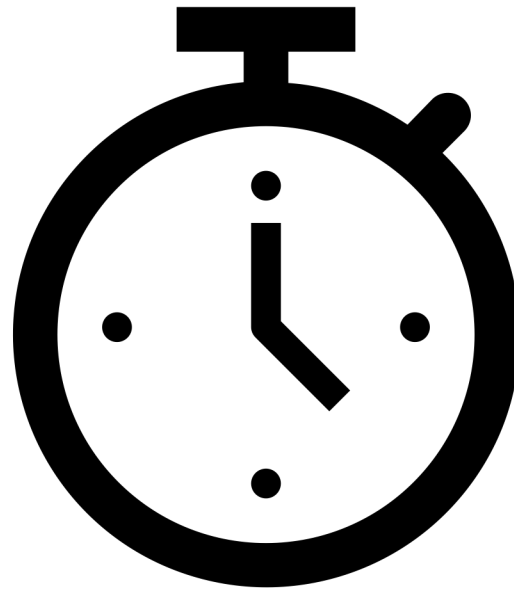

Hotline



Support

24/7 & 1h SLA  
Call us!

# Good communication is the bridge between Confusion and Clarity

~ Nat Turner, Slave Rebel

# The Idea of an “Internet Protocol” (IP)

SHALL WE PLAY A GAME

# IP's Mission: Survive Hell



# IP's Mission: Survive Hell

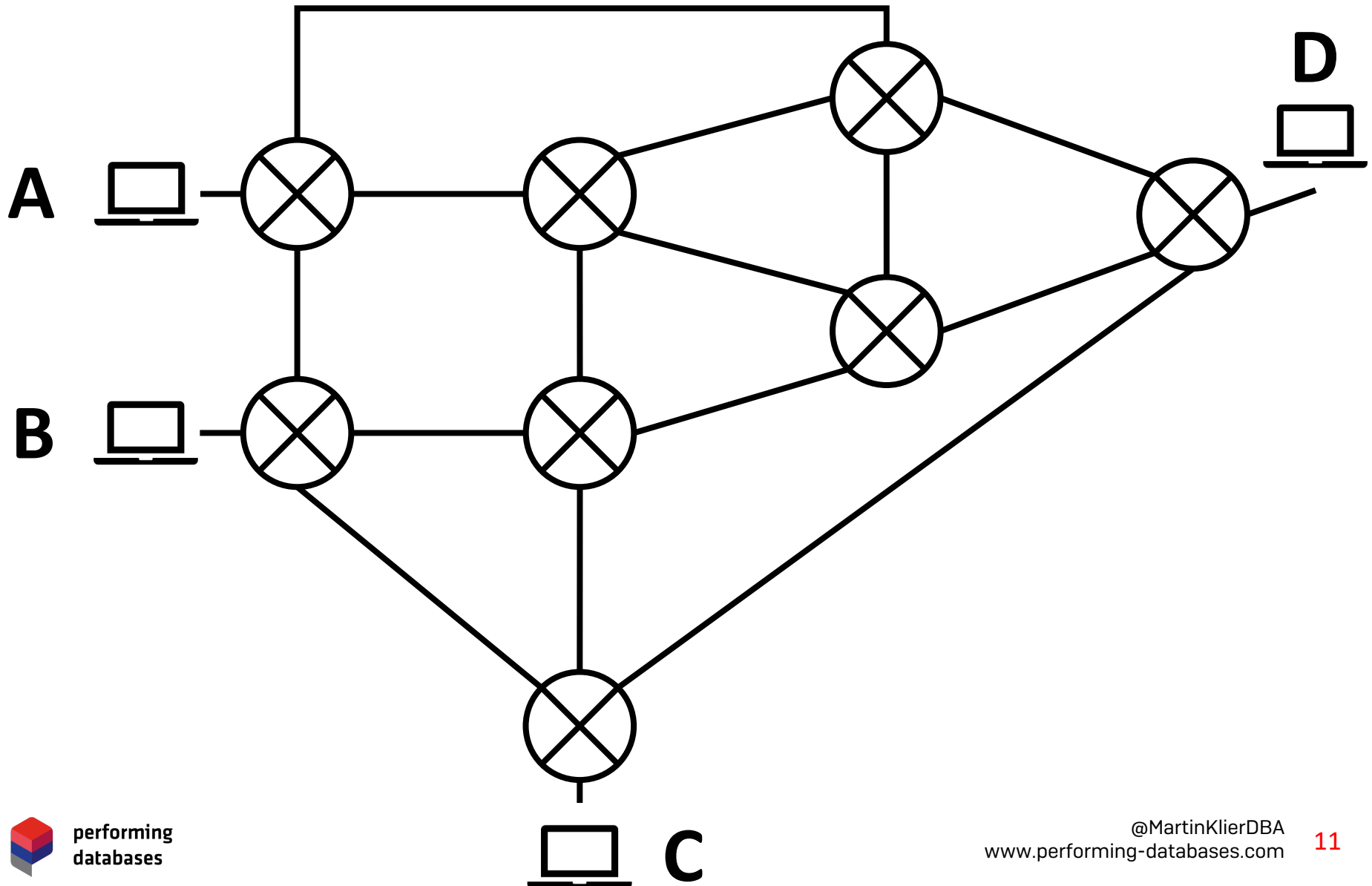

# IP's Mission: Survive Hell





# Disclaimer

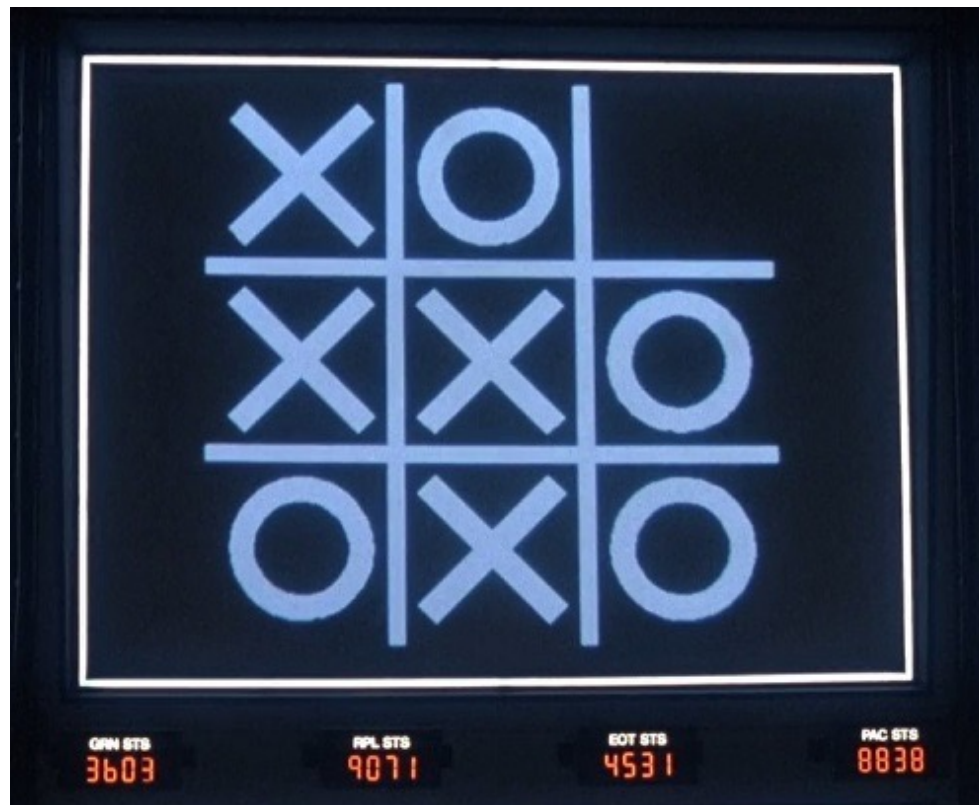

The only winning move is not to play.

# First Things First: Basics

# ISO/OSI's 7 Layer Model



Away!  
Pizza  
Sausage  
Throw  
Not  
Do  
Please

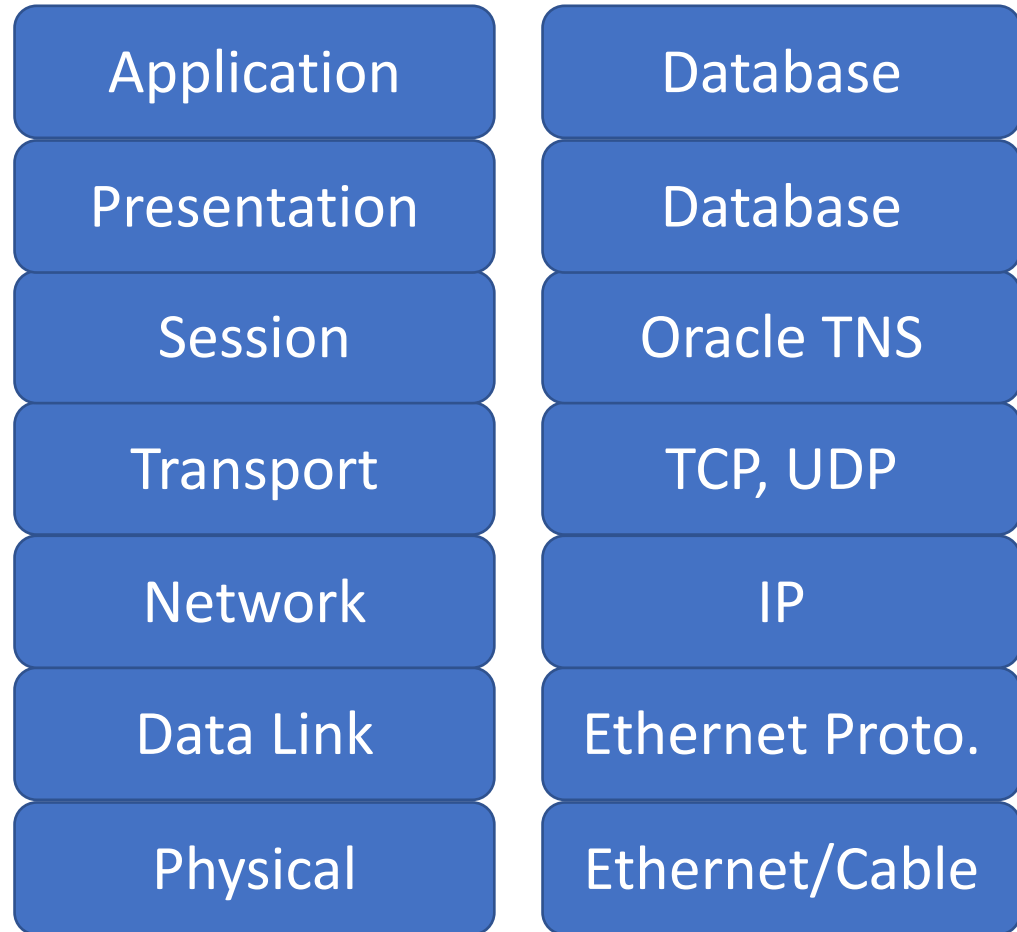

# IP and all the stuff...

# The IP Address

**82.128.9.133**

**082:128:009:133**

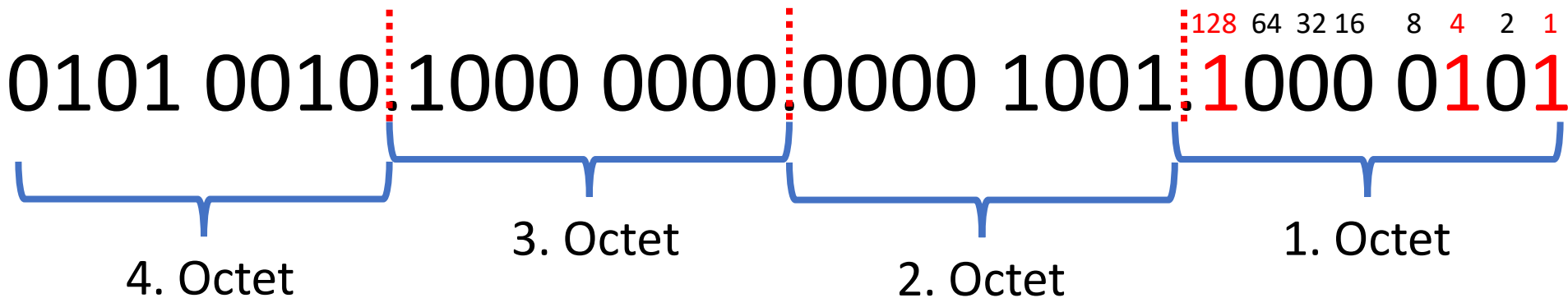

(IPv4 example, concept in IPv6 is similar)



# The IP Network

**82.128.255.255/16**

**082.128.255.255**

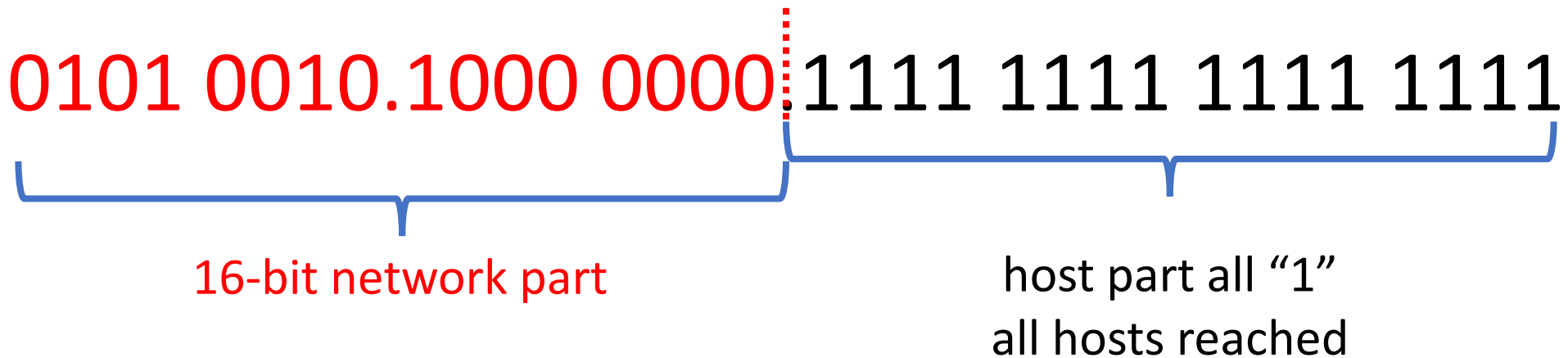

= the "broadcast address"

# The IP Network Mask

Tell the machine where the  
network part ends

**255.255.000.000**

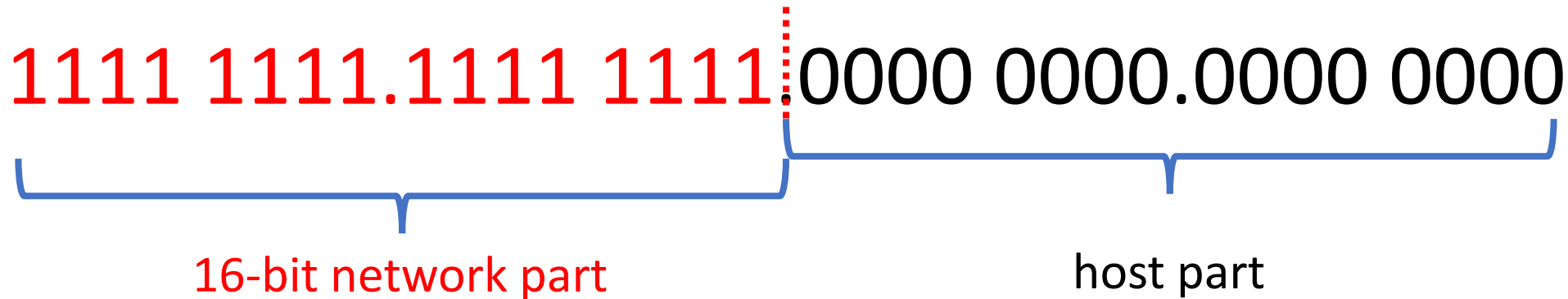

# ~~The IP Network Classes~~

(worked without network masks ...)

255.000.000.000	8bit	<del>Class A</del>
255.255.000.000	16bit	<del>Class B</del>
255.255.255.000	24bit	<del>Class C</del>

Not used for Internet Routing any more

In practice often Octet-Delimiters = Network-Delimiters

We all are lazy. 😊





# Sub and Super



# Subnetting

**082.128.000.000/21**

0101 0010.1000 0000.0000 0000.0000 0000

fixed / foreign-owned 21bits

flexible / my own 11bits

0101 0010.1000 0000.0000 0000.0000 0000

my subnet

my hosts

21+4 bits used for the network now:  
82.128.0.0/25



# Supernetting

## 082.128.000.000/21

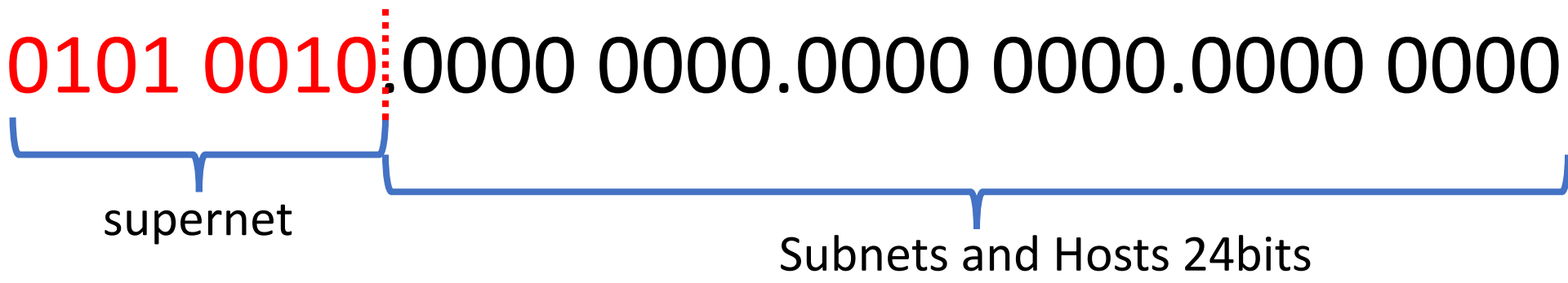

# Routing

# Routing: Connecting Networks

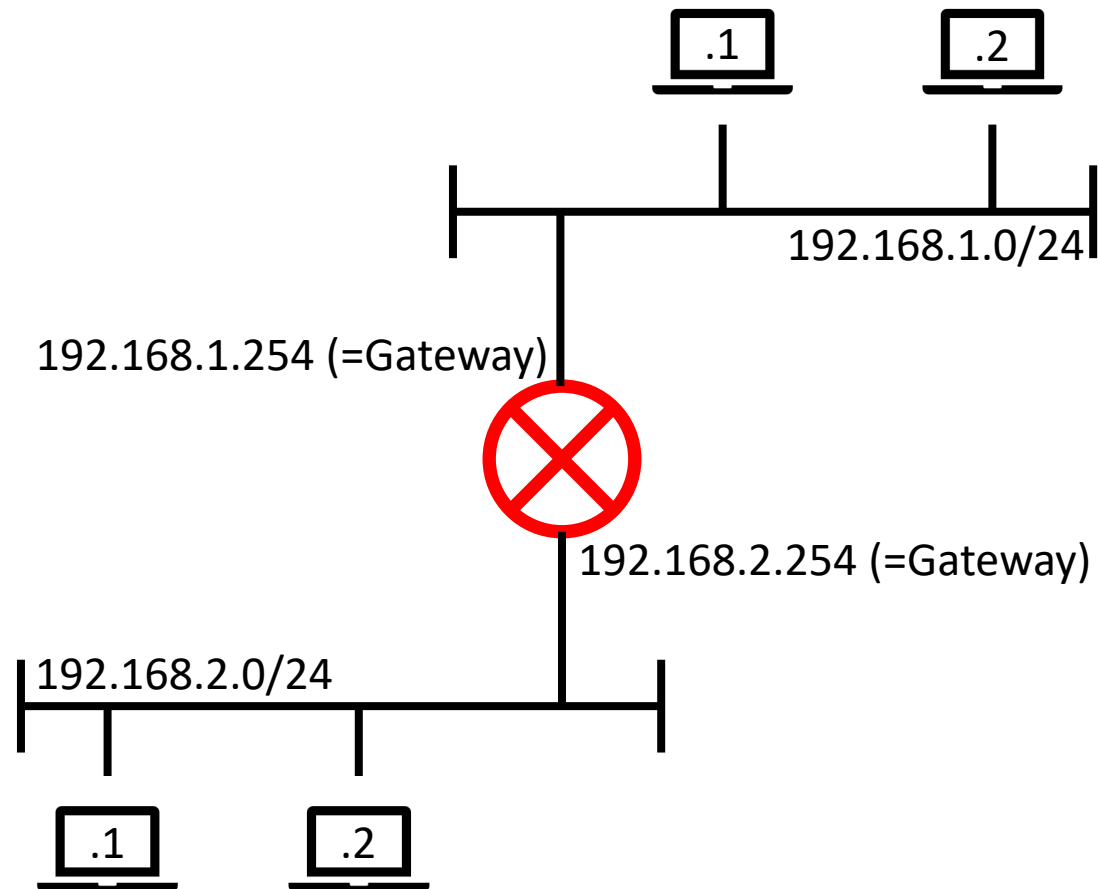

# Routing in Layers

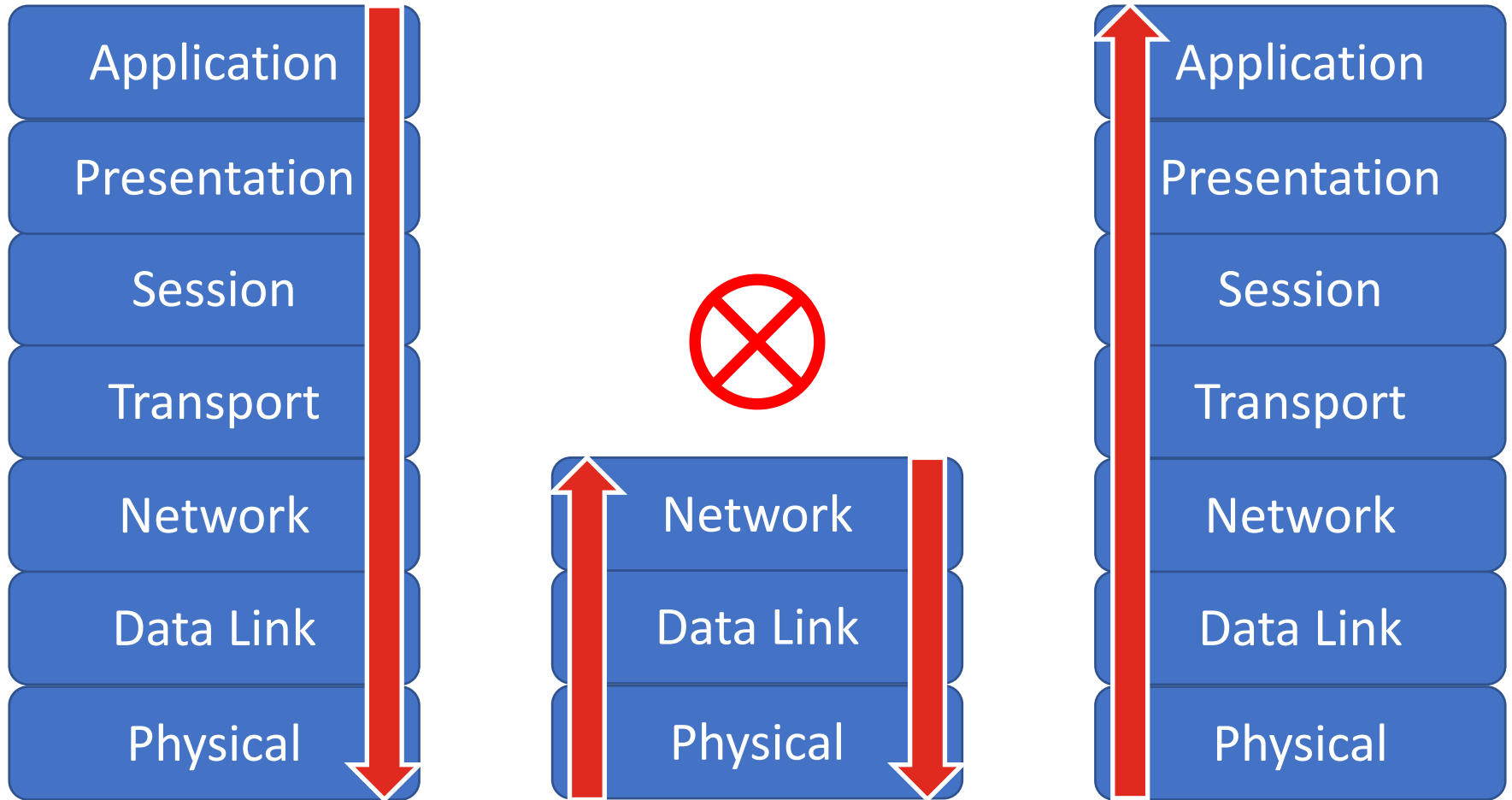

# IP: Routing Around Hell

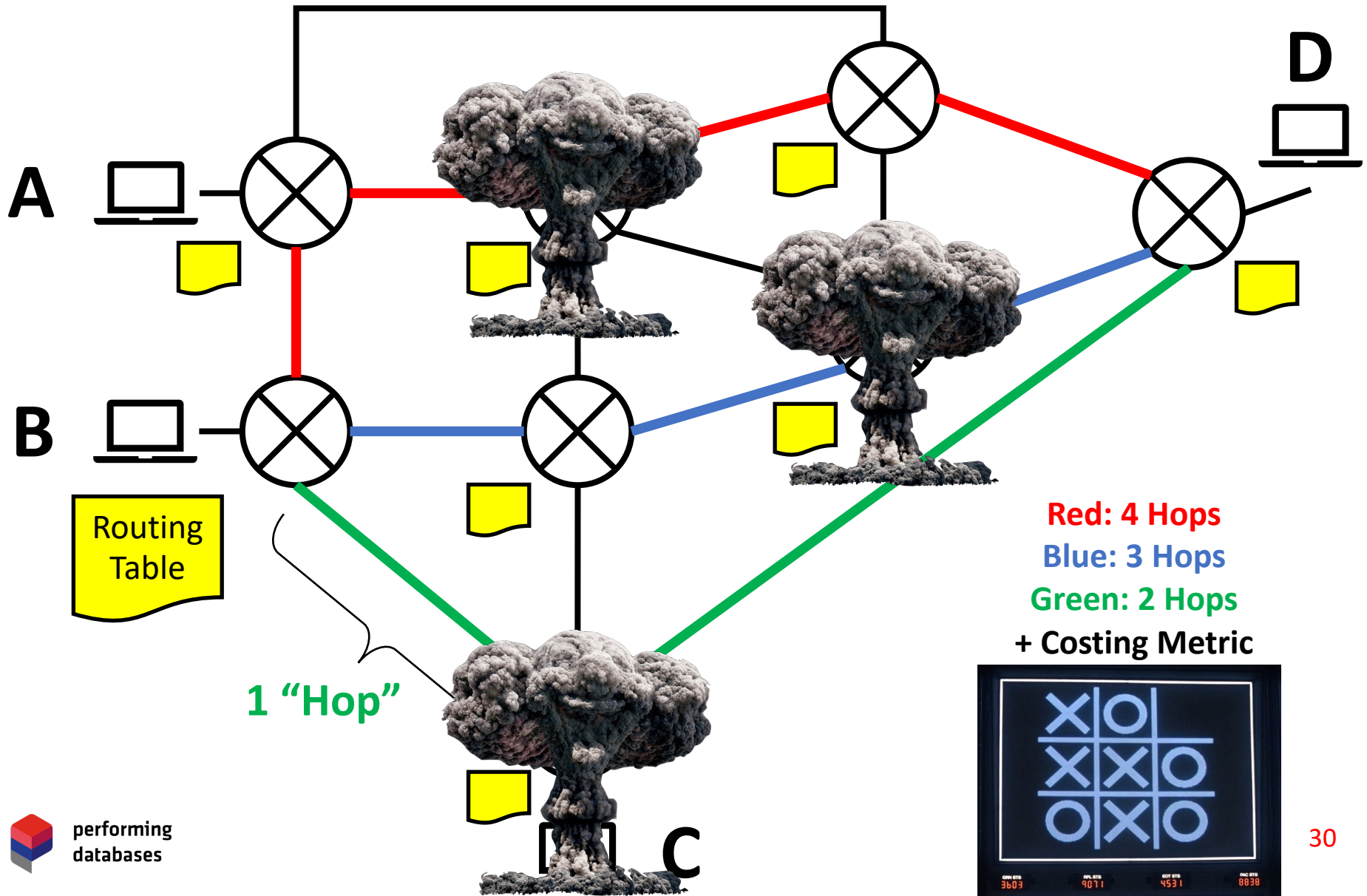

# Finding Hops: traceroute

```
$ traceroute www.bing.com
traceroute to e86303.dscx.akamaiedge.net (2.21.133.203), 64 hops max, 52 byte packets
 1  router.performing-databases.com (10.11.12.254)  3.372 ms  0.302 ms  0.284 ms
 2  172.16.0.1 (172.16.0.1)  0.995 ms  0.508 ms  0.518 ms
 3  62.156.244.46 (62.156.244.46)  17.570 ms  17.099 ms  16.433 ms
 4  62.156.247.146 (62.156.247.146)  18.723 ms  17.507 ms  17.264 ms
 5  b-eh3-i.b.de.net.dtag.de (62.154.46.218)  18.863 ms  17.948 ms  17.900 ms
 6  80.157.206.70 (80.157.206.70)  178.710 ms  57.278 ms  305.652 ms
 7  a2-21-133-203.deploy.static.akamaitechnologies.com (2.21.133.203)  18.831 ms  17.479 ms  17.002 ms
```

```
$ traceroute www.bing.com
traceroute to e86303.dscx.akamaiedge.net (2.21.133.203)
 1  router.performing-databases.com (10.11.12.254)  3.372 ms  0.302 ms  0.284 ms
 2  172.16.0.1 (172.16.0.1)  0.995 ms  0.508 ms  0.518 ms
 3  62.156.244.46 (62.156.244.46)  17.570 ms  17.099 ms  16.433 ms
 4  62.156.247.146 (62.156.247.146)  18.723 ms  17.507 ms  17.264 ms
 5  b-eh3-i.b.de.net.dtag.de (62.154.46.218)  18.863 ms  17.948 ms  17.900 ms
 6  80.157.206.70 (80.157.206.70)  178.710 ms  57.278 ms  305.652 ms
 7  a2-21-133-203.deploy.static.akamaitechnologies.com (2.21.133.203)  18.831 ms  17.479 ms  17.002 ms
```



# Local Addresses

10.0.0.0/8

172.16.0.0/12

192.168.0.0/16

= not routed on the internet

Reserved private IPv4 network ranges<sup>[2]</sup>

Name	CIDR block	Address range	Number of addresses	Classful description
24-bit block	10.0.0.0/8	10.0.0.0 – 10.255.255.255	16 777 216	Single Class A.
20-bit block	172.16.0.0/12	172.16.0.0 – 172.31.255.255	1 048 576	Contiguous range of 16 Class B blocks.
16-bit block	192.168.0.0/16	192.168.0.0 – 192.168.255.255	65 536	Contiguous range of 256 Class C blocks.

# Socket Communication

# The Socket

describes a connection unambiguously

ClientIP:ClientPort – ServerIP:ServerPort

My Macbook connected to an HTTPS Server on the Internet:  
192.168.118.120:50479 connected to 149.154.167.41:443

```
$ netstat -tn | grep tcp4
tcp4      0      0 192.168.118.120.50479 149.154.167.41.443  ESTABLISHED
tcp4      0      0 192.168.118.120.50479 149.154.167.41.443  ESTABLISHED
```

# Network Address Translation (NAT)

(simplified)

```
$ netstat -tn | grep tcp4
tcp4      0      0  192.168.118.120.50479  149.154.167.41.443    ESTABLISHED
tcp4      0      0  192.168.118.130.50082  149.154.167.41.443    ESTABLISHED
```

But wait – Local Address...?

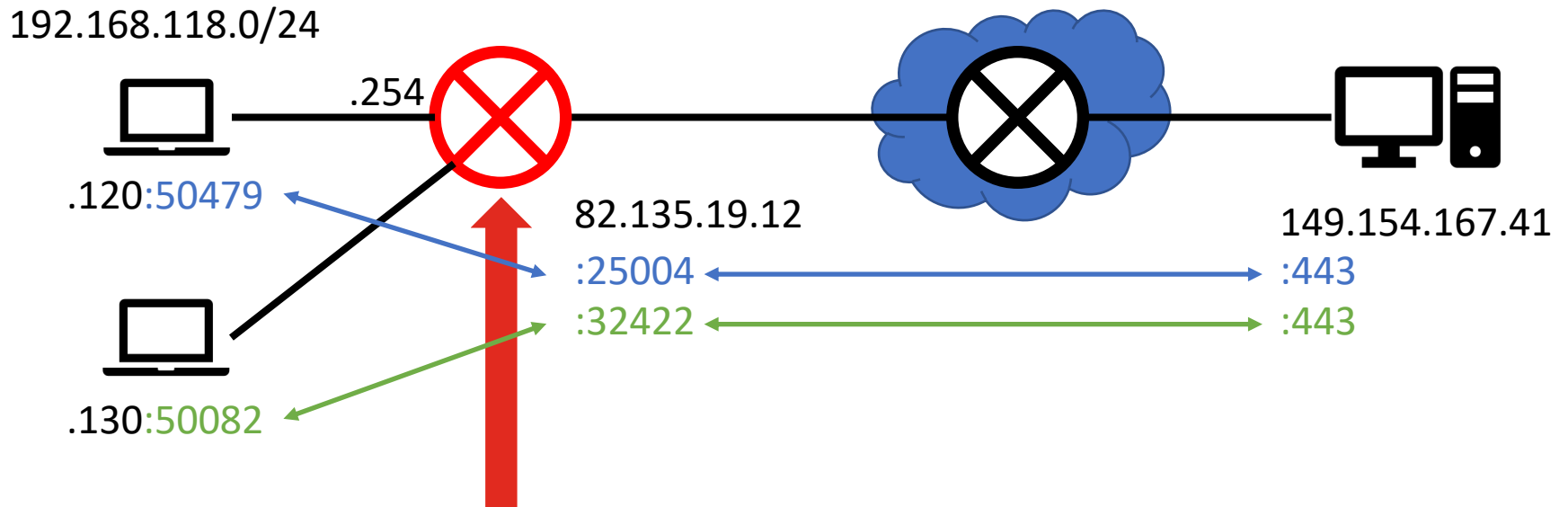

Good spot for the Firewall!

“The single biggest problem  
in communications is the illusion  
that it had taken place.”

~ George Bernard Shaw, Pacifist, Nobel Prize- and Oscar Winner

=> Use TCP for peace!

# Domain Name System (DNS)

# Domain Name

**www.oracle.com**  
herakles.ws27.performing-db.de

hostname      sub domain      domain      top level      root

“Full Qualified Domain Name” (FQDN)

# Forward Resolution

herakles.ws27.performing-db.de.

hostname

sub  
domain

domain

top  
level

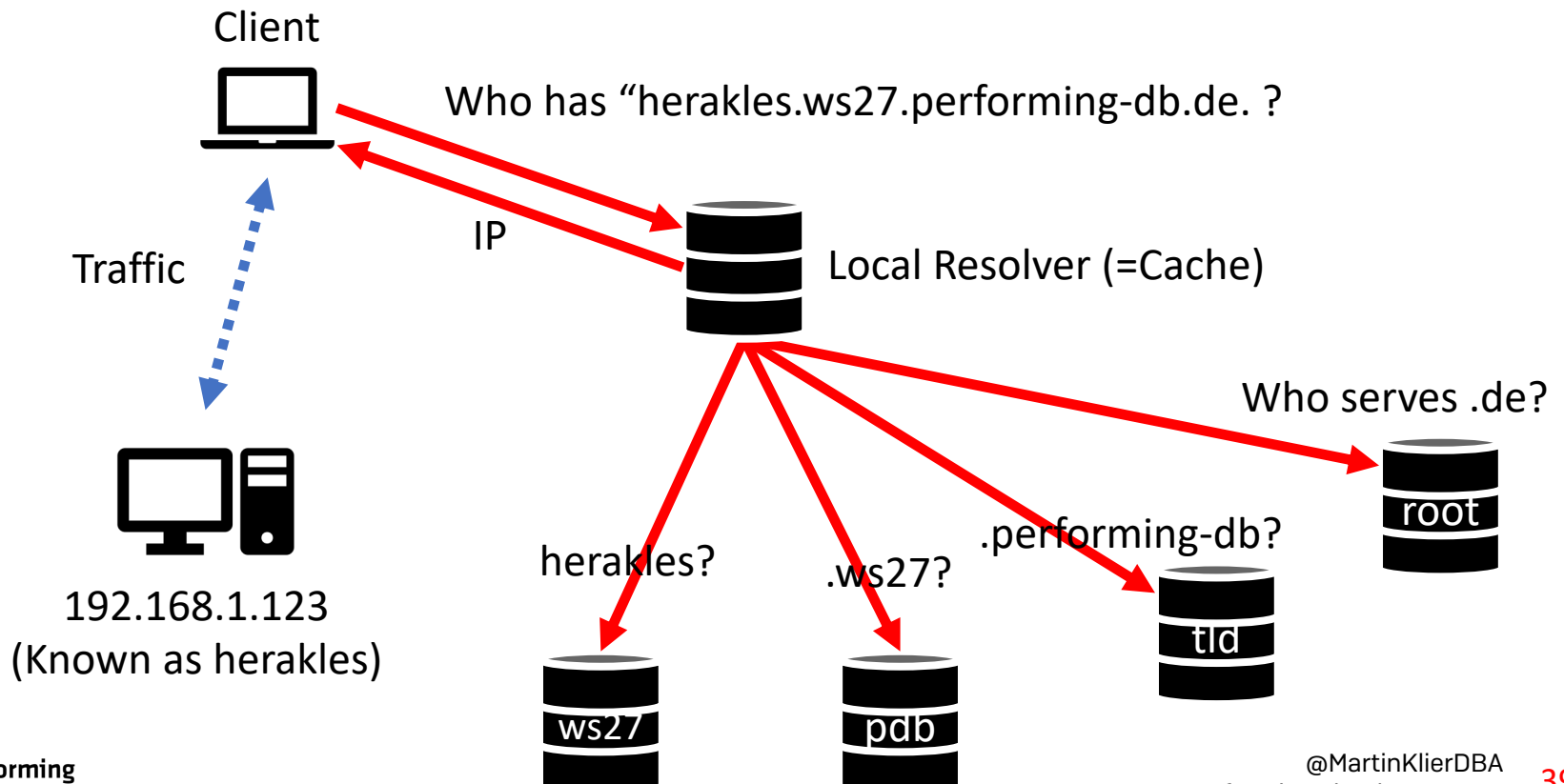

# Forward Resolution

```
$ dig www.performing-databases.com @8.8.8.8

; <<>> DiG 9.10.6 <<>> www.performing-databases.com @8.8.8.8
;; global options: +cmd
;; Got answer:
;; ->>HEADER<<- opcode: QUERY, status: NOERROR, id: 27924
;; flags: qr rd ra; QUERY: 1, ANSWER: 1, AUTHORITY: 0, ADDITIONAL: 1

;; OPT PSEUDOSECTION:
; EDNS: version: 0, flags:; udp: 512
;; QUESTION SECTION:
;www.performing-databases.com.  IN  A

;; ANSWER SECTION:
www.performing-databases.com. 600 IN  A  83.243.40.67

;; Query time: 81 msec
;; SERVER: 8.8.8.8#53(8.8.8.8)
;; WHEN: Wed May 24 22:37:52 CEST 2023
;; MSG SIZE rcvd: 73
```



# Oracle SCAN uses Forward Resolution

```
;; QUESTION SECTION:
```

```
;scan.mydomain. IN A
```

```
;; ANSWER SECTION:
```

```
scan.mydomain. 600 IN A 10.0.0.102
```

```
scan.mydomain. 600 IN A 10.0.0.103
```

```
scan.mydomain. 600 IN A 10.0.0.101
```

If done by any TNS EZconnect client, this leads to a tnsnames.ora-like ADDRESS\_LIST:

```
(ADDRESS_LIST = (ADDRESS = (Host = 10.0.0.102))  
                (ADDRESS = (Host = 10.0.0.103))  
                (ADDRESS = (Host = 10.0.0.101)))
```

# Reverse Resolution

```
$ dig -x 217.237.148.70
```

```
; <<> DiG 9.10.6 <<> -x 217.237.148.70
```

```
;; global options: +cmd
```

```
;; Got answer:
```

```
;; ->HEADER<- opcode: QUERY, status: NOERROR, id: 29500
```

```
;; flags: qr rd ra; QUERY: 1, ANSWER: 1, AUTHORITY: 0, ADDITIONAL: 1
```

```
;; OPT PSEUDOSECTION:
```

```
; EDNS: version: 0, flags:: udp: 512
```

```
;; QUESTION SECTION:
```

```
;70.148.237.217.in-addr.arpa. IN PTR
```

```
;; ANSWER SECTION:
```

```
70.148.237.217.in-addr.arpa. 15337 IN PTR d-lb-a01.isp.t-ipnet.de.
```

```
;; Query time: 311 msec
```

```
;; SERVER: 2a01:598:b037:d768::49#53(2a01:598:b037:d768::49)
```

```
;; WHEN: Wed May 24 23:06:07 CEST 2023
```

```
;; MSG SIZE rcvd: 93
```



# The Black Hole

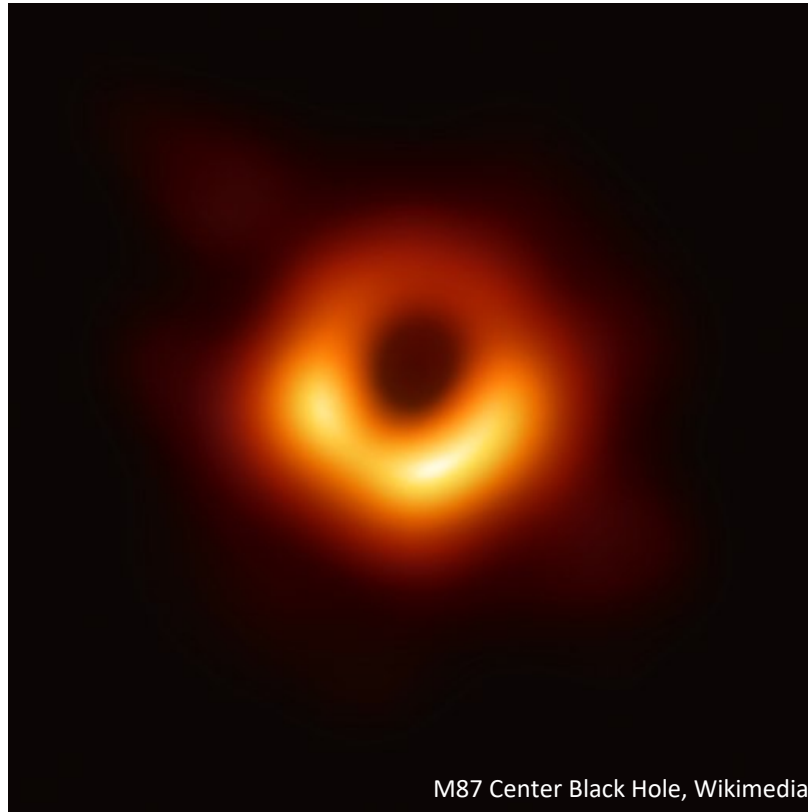

M87 Center Black Hole, Wikimedia

blackhole-1.iana.org (192.175.48.6)  
blackhole-2.iana.org (192.175.48.42)  
prisoner.iana.org (192.175.48.1)

## DNS Reverse Lookup for Local Addresses

# 1% of Practice

# Connecting via Listener

Database Server  
192.168.0.100



Client  
192.168.0.200

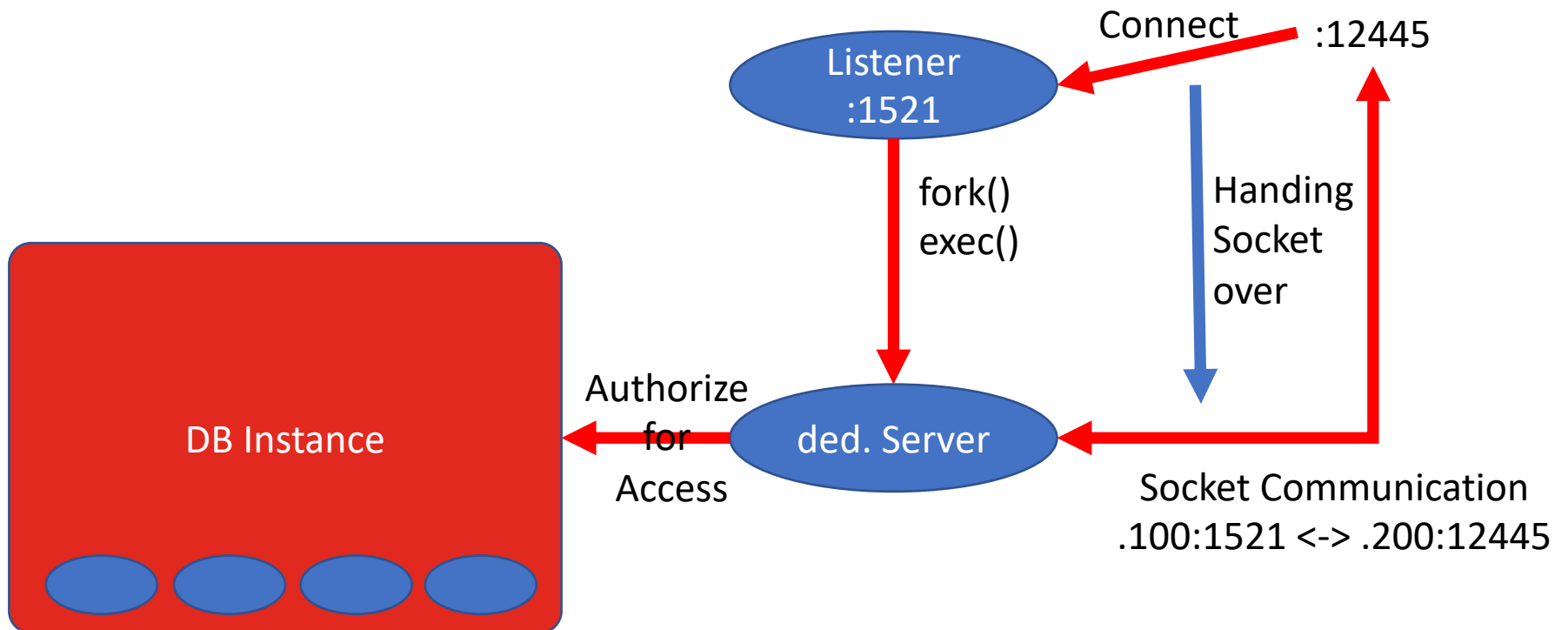

# What we did today...

- 📦 Learned about the idea of IP to route around hell
- 📦 7 Layers of Pain
- 📦 IP Addresses, Networks, Subs and Supers
- 📦 Translating Network Addresses for your safety
- 📦 Domain Names and where to find them
- 📦 The Black Hole of the Internet
- 📦 DO NOT PLAY!

GREETINGS PROFESSOR FALKEN

HELLO

A STRANGE GAME.

THE ONLY WINNING MOVE IS  
NOT TO PLAY.

HOW ABOUT A NICE GAME OF CHESS?



# Meet & Greet

[martin.klier@performing-db.com](mailto:martin.klier@performing-db.com)

[www.performing-databases.com](http://www.performing-databases.com)



April 15-17, 2026  
MS Colour-Fantasy  
Oslo, Norway – Kiel, Germany  
and back to Oslo

**TNS Connections – WTF?  
Tomorrow 5 p.m. Auditorium 1  
M/S Color Fantasy**

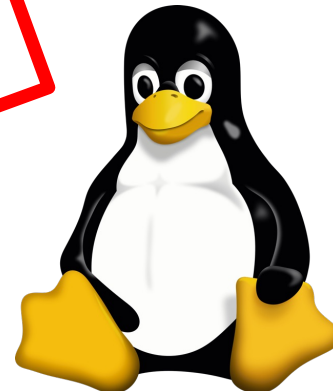

Linux User Group  
Mitterteich

3. Wednesday of Month

# Bonus: Who spotted the Clown?



# Fast Data Platforms. Aus der Oberpfalz!

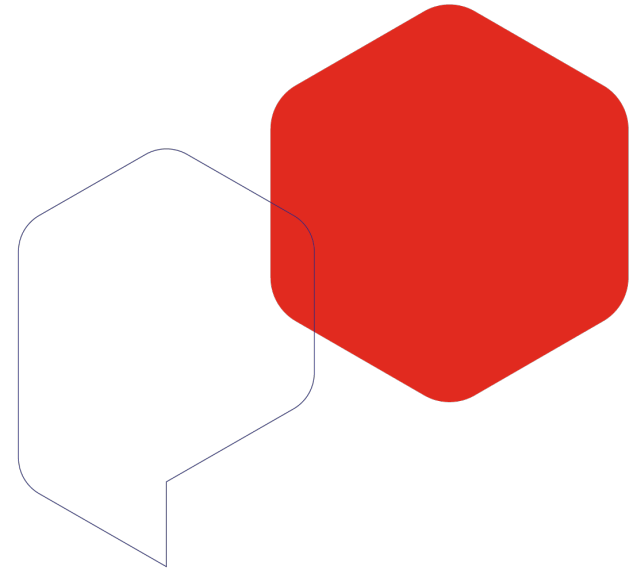

[martin.klier@performing-db.com](mailto:martin.klier@performing-db.com)

<http://www.performing-databases.com>



**performing  
databases**



**performing  
databases**

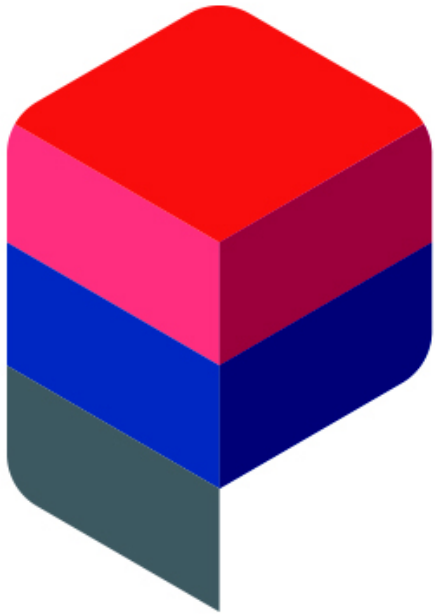

**performing  
databases**